

# ISNG BASIC RANGE

## ISNG 0250 to ISNG 7500

Spring Type/ Part Number	Spring Force N (lbs)		Piston Ø mm	Body Ø mm	C mm	Max. stroke PS.	L min	L +0 -1	Service Kit
	Initial	Maximum							
ISNG 0250/10	2500 N	4100 N	14	38	2	9	60	70	33-23-99
ISNG 0250/12.7	(550)	(920)				11.7	62.7	75.4	
ISNG 0250/16						15	66	82	
ISNG 0250/25						24	75	100	
ISNG 0250/38.1						37.1	88.1	126.2	
ISNG 0250/50						49	100	150	
ISNG 0250/63.5						62.5	113.5	177	
ISNG 0250/80						79	130	210	
ISNG 0250/100						99	150	250	
ISNG 0500/12.7	5000 N	71000 N	20	45	2	11	97.7	110	33-24-00
ISNG 0500/25	(1102)	(1565)				23	110	135	
ISNG 0500/38.1						36	123.1	161	
ISNG 0500/50						48	135	185	
ISNG 0500/63.5						61	148.5	212	
ISNG 0500/80						78	165	245	
ISNG 0500/100						98	185	285	
ISNG 0750/12.7	7500 N	12300 N	25	50	3	11	107.7	120	33-24-01
ISNG 0750/25	(1653)	(2711)				23	120	145	
ISNG 0750/38.1						36	133.1	171	
ISNG 0750/50						48	145	195	
ISNG 0750/63.5						61	158.5	222	
ISNG 0750/80						78	175	255	
ISNG 0750/100						98	195	295	
ISNG 0750/125						123	220	345	
ISNG 0750/160						158	255	415	
ISNG 1500/25	15000 N	22300N	36	75	3	23	135	160	33-24-02
ISNG 1500/38.1	(3306)	(4907)				36	148.1	186	
ISNG 1500/50						48	160	210	
ISNG 1500/63.5						61	173.5	237	
ISNG 1500/80						78	190	270	
ISNG 1500/100						98	210	310	
ISNG 1500/125						123	235	360	
ISNG 1500/160						158	270	430	
ISNG 3000/25	30000 N	45000 N	50	95	3	23	145	170	33-24-03
ISNG 3000/38.1	(6613)	(9920)				36	158.1	196	
ISNG 3000/50						48	170	220	
ISNG 3000/63.5						61	183.5	247	
ISNG 3000/80						78	200	280	
ISNG 3000/100						98	220	320	
ISNG 3000/125						123	245	370	
ISNG 3000/160			158	280	440				
ISNG 5000/25	50000 N	75600 N	65	120	3	23	165	190	33-24-04
ISNG 5000/38.1	(11,023)	(16,666)				36	178.1	216	
ISNG 5000/50						48	190	240	
ISNG 5000/63.5						61	203.5	267	
ISNG 5000/80						78	220	300	
ISNG 5000/100						98	240	340	
ISNG 5000/125						123	265	390	
ISNG 5000/160						158	300	460	
ISNG 7500/25	75000 N	105000 N	80	150	3	23	180	205	33-24-05
ISNG 7500/38.1	(16,534)	(23,148)				36	193.1	231	
ISNG 7500/50						48	205	255	
ISNG 7500/63.5						61	218.5	282	
ISNG 7500/80						78	235	315	
ISNG 7500/100						98	255	355	
ISNG 7500/125						123	280	405	
ISNG 7500/160			158	315	475				

When ordering the gas spring you require, also consider the type of mounting, and include this in the Spring Type/Part Number. For example ISNG 5000/63.5 RSF. Full range of mounting examples are listed on page 3 and 4.

Special sizes are available upon request up to 300mm



# ISNG BASIC RANGE

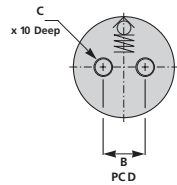
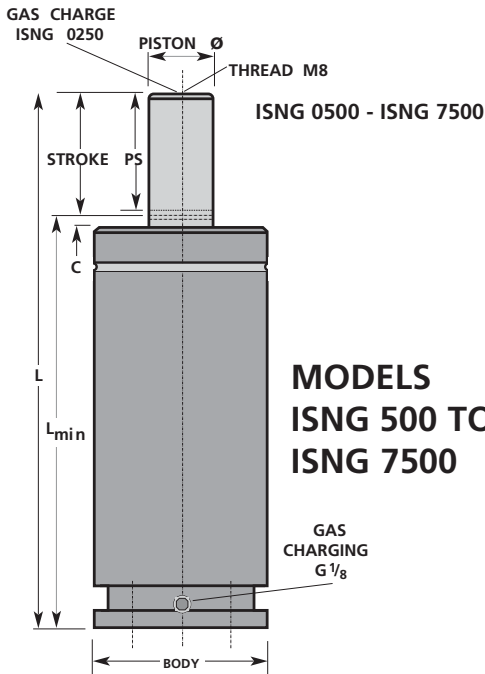

ISNG0500 STYLE CYLINDER  
ISNG0750 STYLE CYLINDER

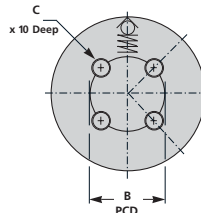

ISNG 1500 TO ISNG 7500  
STYLE CYLINDER

## Fixing Centres

Type	B	C
ISNG 0250	-	-
ISNG 0500	20	2xM8
ISNG 0750	20	2xM8
ISNG 1500	40	4xM8
ISNG 3000	60	4xM8
ISNG 5000	80	4xM10
ISNG 7500	100	4xM10

## GAS SPRING DATA

Use only Nitrogen.  
Max. Pressure 150 Bar.  
Min. Pressure 50 Bar.  
Max. Piston Velocity 38m/min.  
Max Side Force 0.20<sup>0</sup>  
Suitable for CNOMO Hoses

## FORCE ON IMPACT

ISNG Basic Range

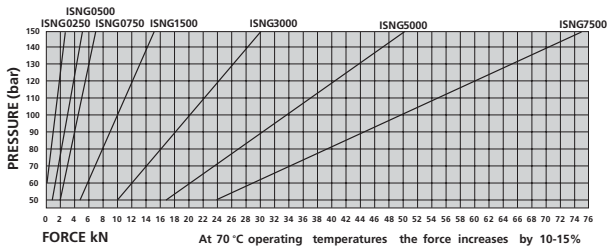

## Character Curves for Basic Range

ISNG 0250, 0500, 0750, 1500, 3000, 5000, 7500

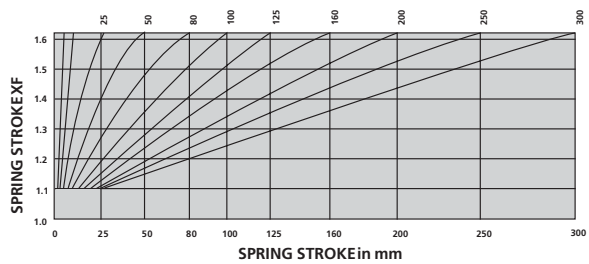

## Mounting Examples

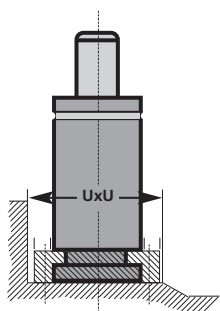

Square Flange (SF)  
or Reverse Square Flange (RSF)  
or Flange Feet (F)

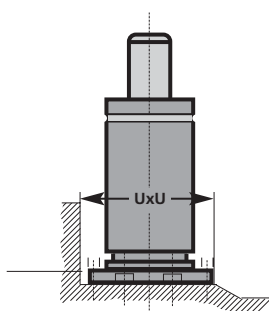

Base Plate (BP)

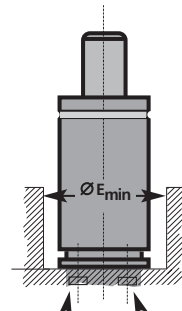

Tapped Holes (TH)  
(NB Not ISNG0250)

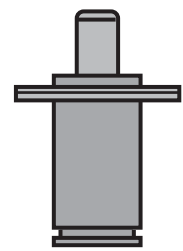

Front Flange (FF)  
NB If mounted horizontally  
an end support  
must be used (ES)

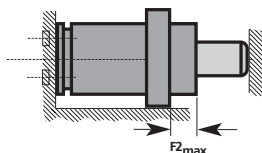

Tapped Holes (ES)  
with end supports

## Basic Dimensions

Type	F2	E	U
ISNG 0500	0	46.5	90
ISNG 0750	25	51.5	90
ISNG 1500	30	76.5	115
ISNG 3000	40	96.5	135
ISNG 5000	50	122	155
ISNG 7500	60	153	185

## How to Order:

Spring Type x Stroke + Mounting Type  
i.e. ISNG 1500 x 25 + Mounting Type

See pages 19 - 23 for  
Fastening Examples.

